



# Dynapac CC900

## Double drum vibratory rollers





### Technical data

 <b>Masses</b>	
Max. operating mass	1665 kg
Operating mass (incl. ROPS)	1600 kg
Module mass (front/rear)	750 kg/850 kg

 <b>Compaction</b>	
Centrifugal force	17 kN
Nominal amplitude	0.4 mm
Static linear load (front/rear)	8.3/9.4 kg/cm
Vibration frequency	70 Hz
Water tank	110 l

 <b>Hydraulic system</b>	
Driving	Axial piston pump with variable displacement and servo. 2 radial piston motors with constant displacement.
Vibration	Gear pump/motors with constant displacement.
Steering	Gear pump with constant displacement.
Service brake	Hydrostatic in forward and reverse lever.
Parking/ Emergency brake	Failsafe brake in both drums.

 <b>Engine</b>	
Manufacturer/Model	Kubota D1105-E4B T4f/V
Type	Water cooled diesel
Rated power, SAE J1995	18 kW (24 hp ) @ 2800 rpm
Fuel tank capacity	23 l

 <b>Traction</b>	
Speed range (Dual/TC/AS)	0-9 km/h
Vertical oscillation	±13°

Find us locally at [www.dynapac.com](http://www.dynapac.com)

We reserve the right to change specifications without notice. Photos and illustrations do not always show standard versions of machines. The above information is a general description only, all informations are supplied without liability.

# Dynapac CC900

## Double drum vibratory rollers



### Technical data

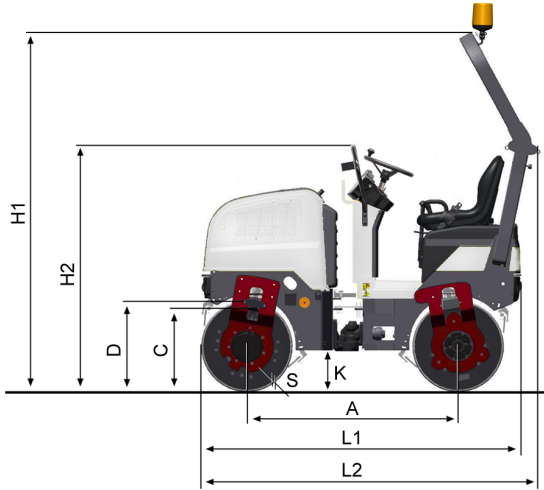

Dimensions	
A. Wheelbase	1350 mm
B. Width	970 mm
C. Curb clearance	465 mm
D. Drum diameter	584 mm
H1. Height, with ROPS/cab	2300 mm
H2. Height, w/o ROPS/cab	1585 mm
K. Ground clearance	255 mm
L1. Length	2040 mm
L2. Length (ROPS)	2095 mm
O1. Overhang, right	35 mm
O2. Overhang, left	35 mm
R1. Turning radius, outside	2810 mm
S. Drum shell thickness	12 mm
W. Drum width	900 mm
$\alpha$ . Steering angle	$\pm 34^\circ$

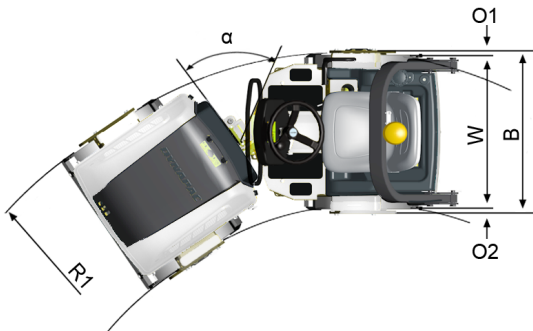

Find us locally at [www.dynapac.com](http://www.dynapac.com)

We reserve the right to change specifications without notice. Photos and illustrations do not always show standard versions of machines. The above information is a general description only, all informations are supplied without liability.